



ASSEMBLY INSTRUCTION

ORLANDO CORNER CHAISE AND OTTOMAN

ITEM CODE: 64846

Imported by Amart Furniture Pty Ltd, Qld, Brisbane Australia.

For any assistance with assembly or for missing parts please phone Amart Furniture Ewing Road, Customer Service Free call 1800 351 084

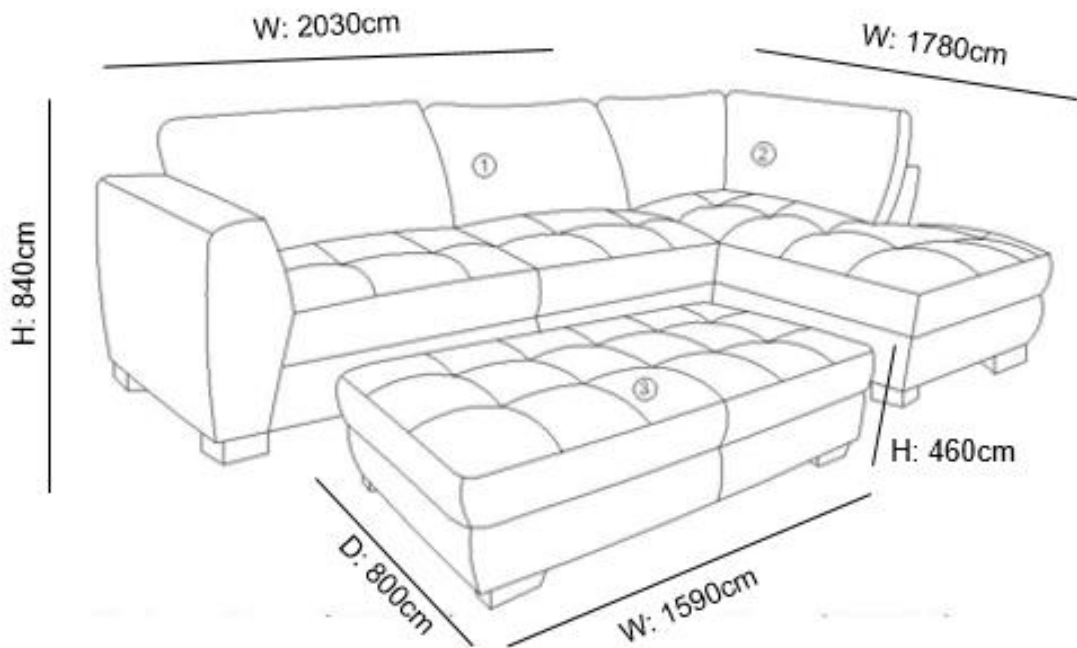

Imported by Amart Furniture Pty Ltd, Qld, Brisbane Australia.

For any assistance with assembly or for missing parts please phone Amart Furniture Ewing Road, Customer Service Free call 1800 351 084

PRE-ASSEMBLY PREPARATION

Before you start:

1. Choose a clean, level, spacious assembly area. Avoid hard surfaces that may damage the product
2. Take care when lifting. Product should be assembled as near as possible to the point of use
3. Ensure that you have all required contents for complete assembly
4. Always read the assembly instructions carefully before beginning assembly.
5. Keep all hardware parts and packaging out of reach of small children.
6. Do not over tighten the screws and bolts as this may damage the threads



5

ALLOW MINUTES







1



PEOPLE REQUIRED

PARTS LIST



Hardware List (CARTON 1)

A		Foot	4PCS
B		Screws (MS*6000)	4PCS
C		Middle leg	1PC
D		Plastic Washer	1PC

Hardware List (CARTON 2)

A		Foot	4PCS
B		Screws (MS*6000)	4PCS

Hardware List (CARTON 3)

A		Foot	4PCS
B		Screws (MS*6000)	4PCS

PLEASE NOTE:PIECES REQUIRED FOR ASSEMBLY ARE LOCATED INSIDE THE DUST COVER UNDERNEATH SOFA

STEP 1 Turn over onto blanket or carpet to ensure no damage to item. Align base plates of each foot with the pre-threaded holes in the undersides of the sofa as shown in the below diagram. Insert Bolt (B) in to legs and tight. Insert center leg (C) remaining holes. Tighten all Screws and Bolts securely.

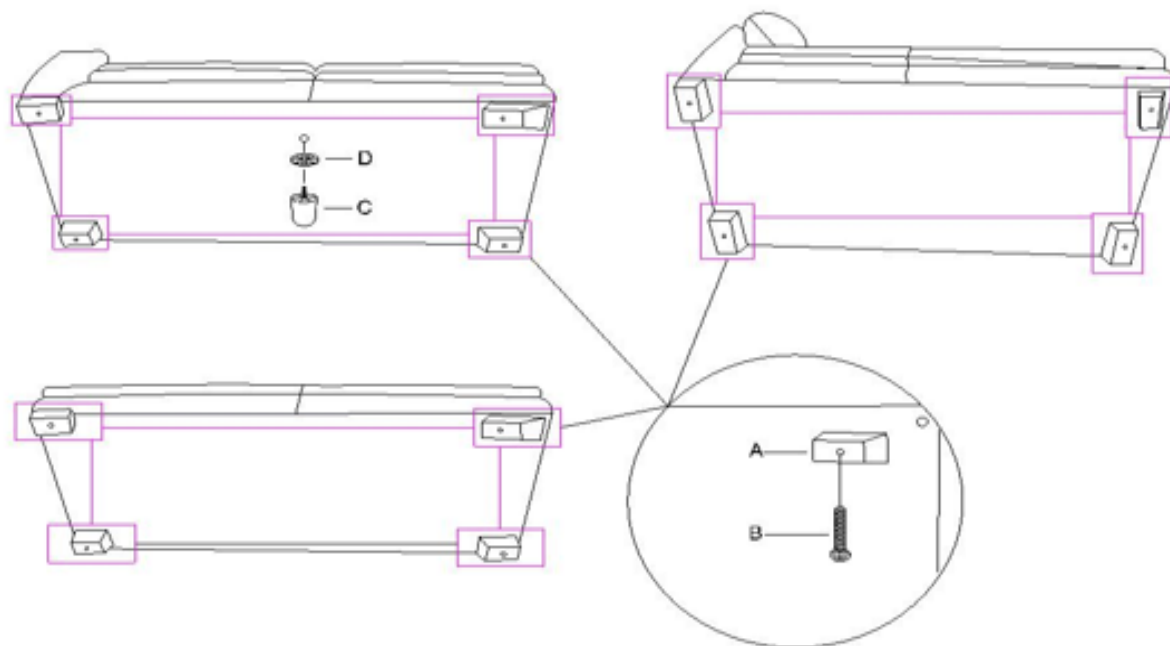

STEP 2 Assembly complete

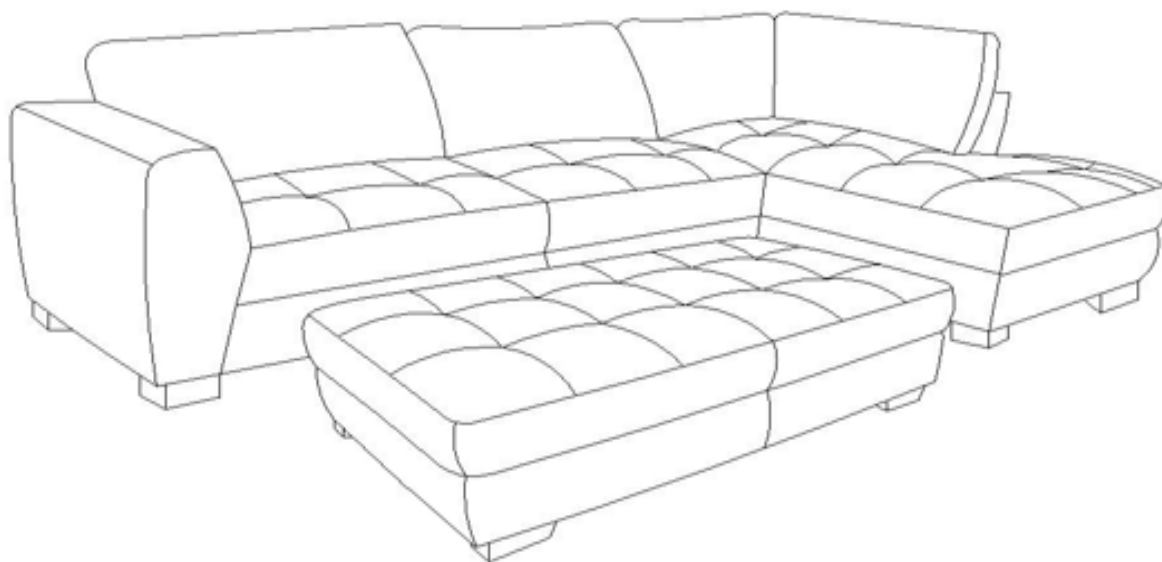

IMPORTANT: Please ensure feet are tightened securely before use!

CARE AND MAINTENANCE

EASY TO CLEAN COVER (FRAME)

WHEN NECESSARY BRUSH OR VACUUM AWAY DUST AND GRIT. WIPE OVER WITH A SOFT, CLEAN, DYEFAST CLOTH.

FOR SPOTS AND SPILLS:
WIPE EXCESS LIQUID UP IMMEDIATELY WITH AN ABSORBANT CLOTH OR SPONGE.

NOTES:
ACCUMULATION OF PERSPIRATION AND BODY OILS ON ARMPADS, HEADREST ECT. MAY DAMAGE YOUR COVER- THESE AREAS MAY REQUIRE MORE FREQUENT CLEANING.

DO NOT EXPOSE COVER TO DIRECT SUNLIGHT; INTENSIVE HEAT; WEATHER; OR SOAK UNNECESSARILY. ALWAYS AVOID EXCESSIVE HARD RUBBING.

DO NOT DRY CLEAN OR MACHINE WASH.

DO NOT USE SADDLE SOAP; DETERGENTS; SOLVENTS; ABRASIVES; UNIDENTIFIED LEATHER CLEANERS; SUEDE CLEANERS OR ANY PRODUCTS CONTAINING SILICON OR SOLVENTS.